

Návod k montáži
pětiúhelníkový sprchový kout HYD-PK91

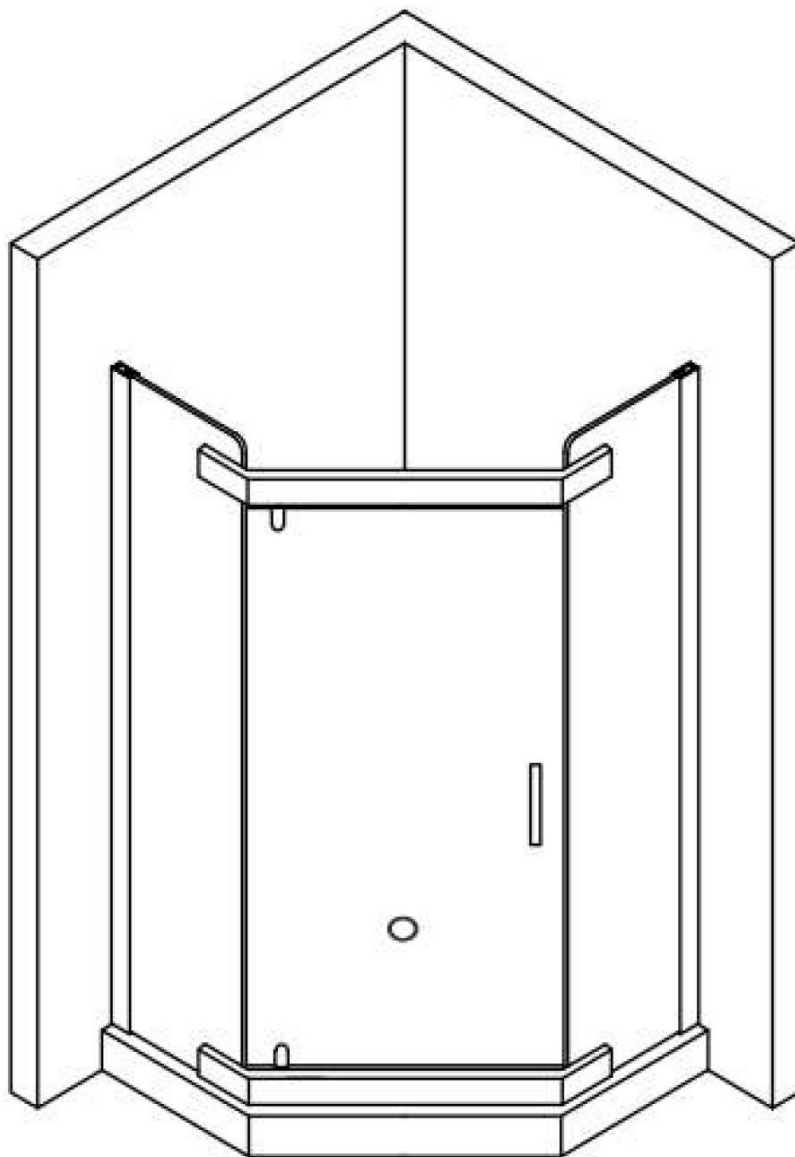

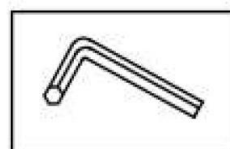

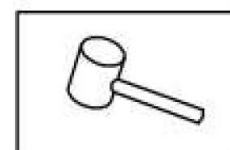

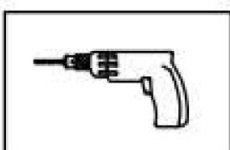
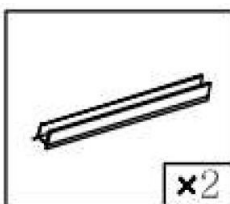
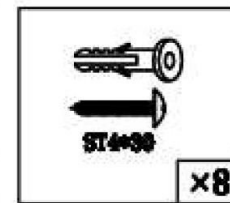
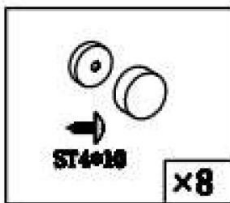
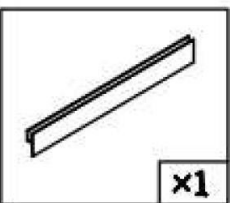
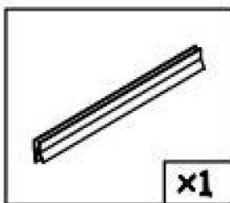
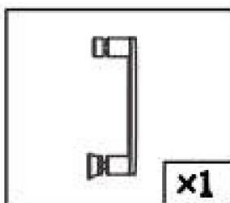
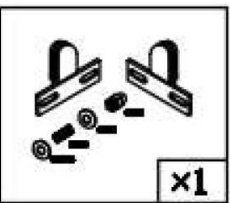
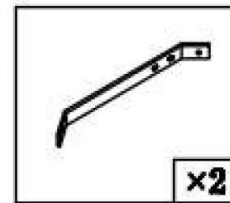
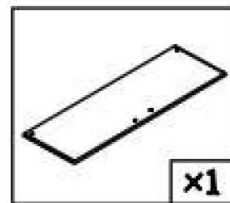
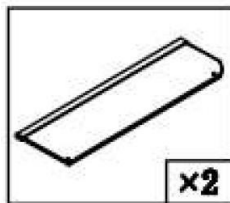
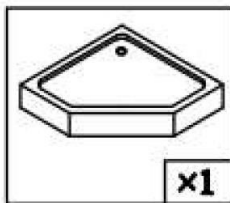
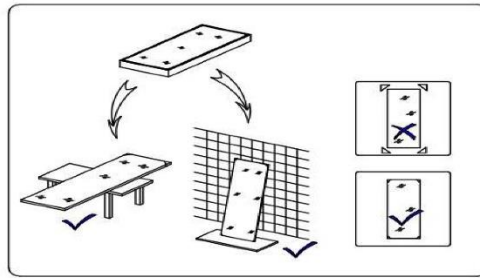
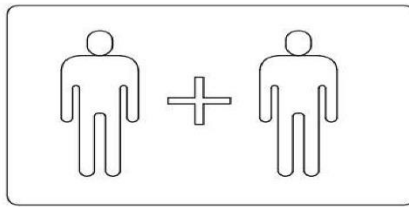
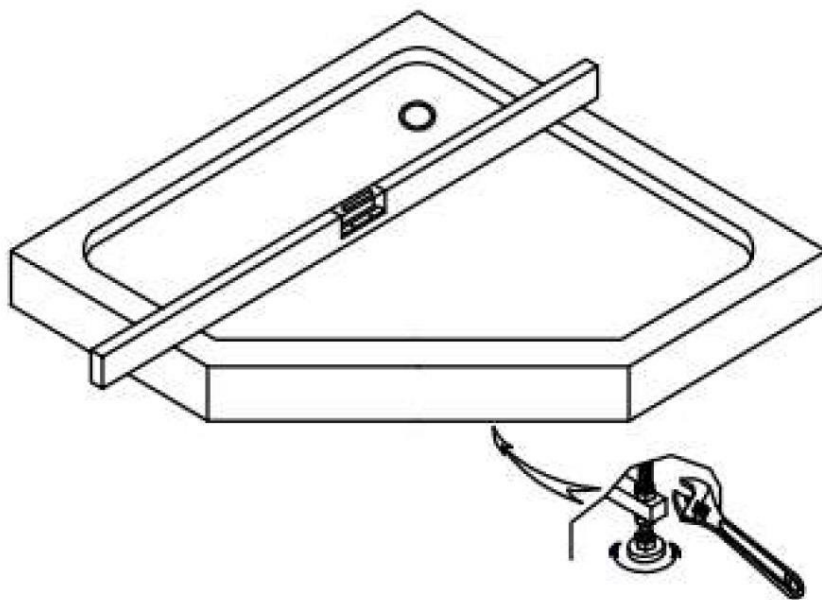
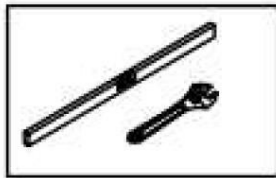
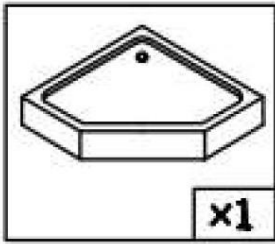
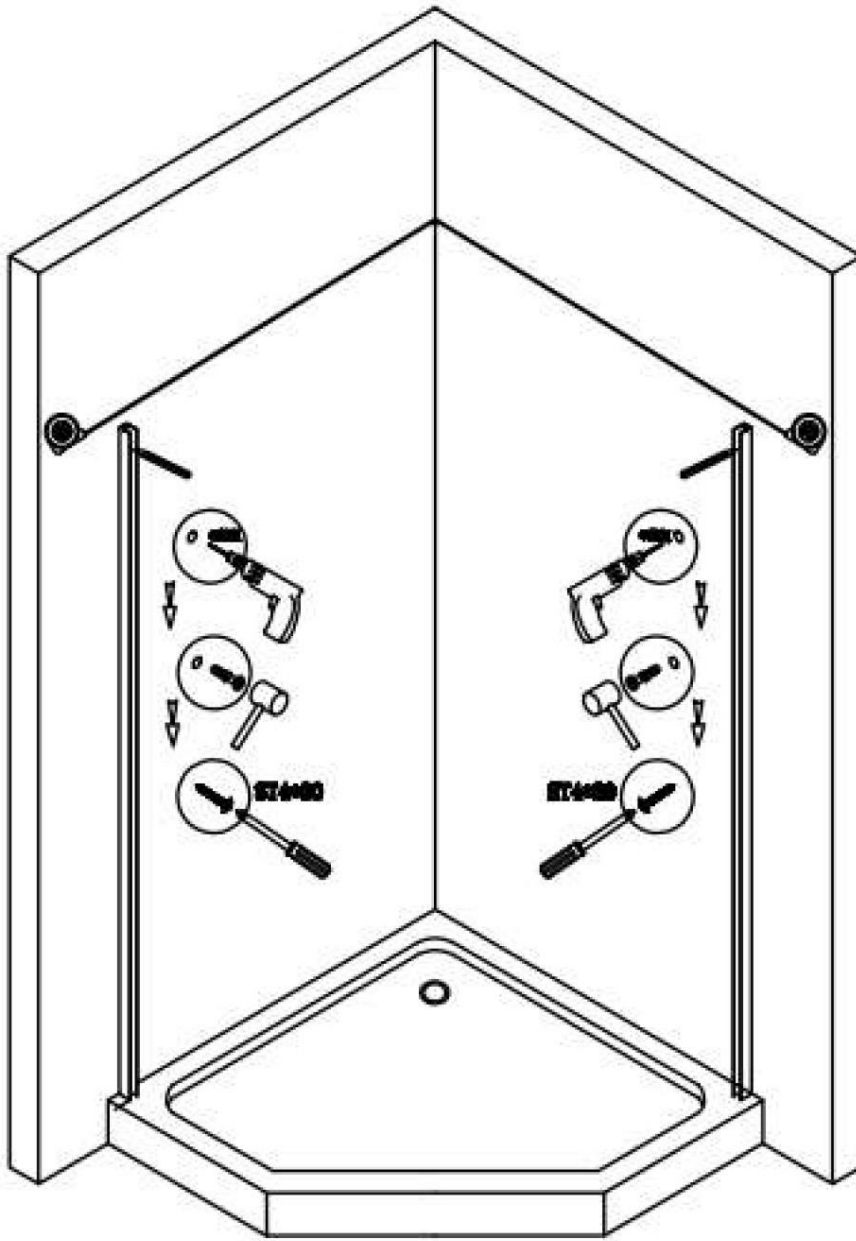
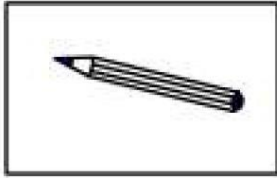
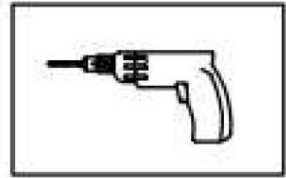
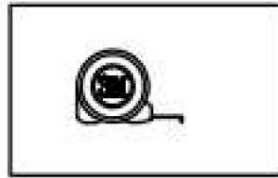
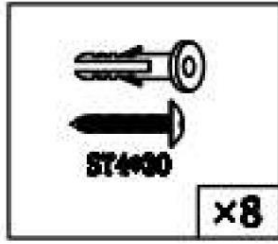
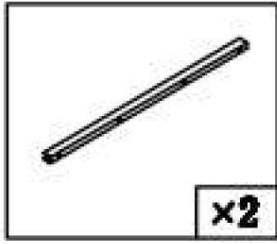

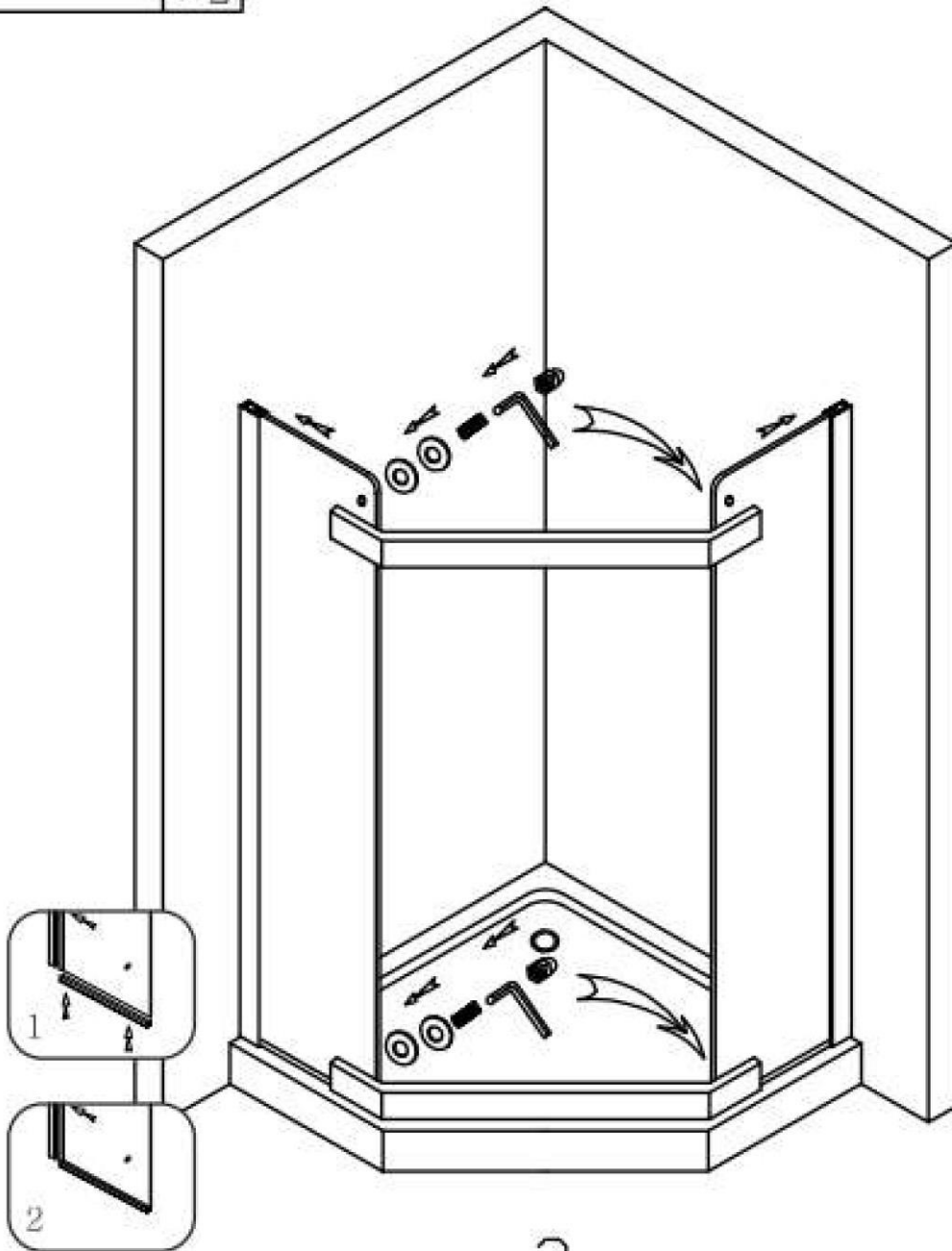
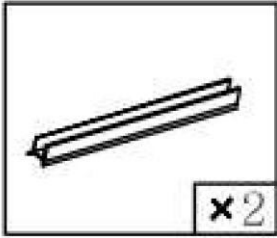
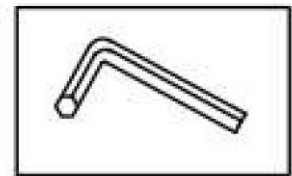
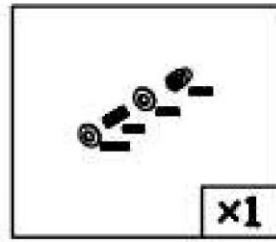
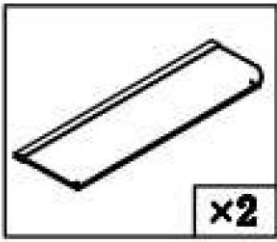

3

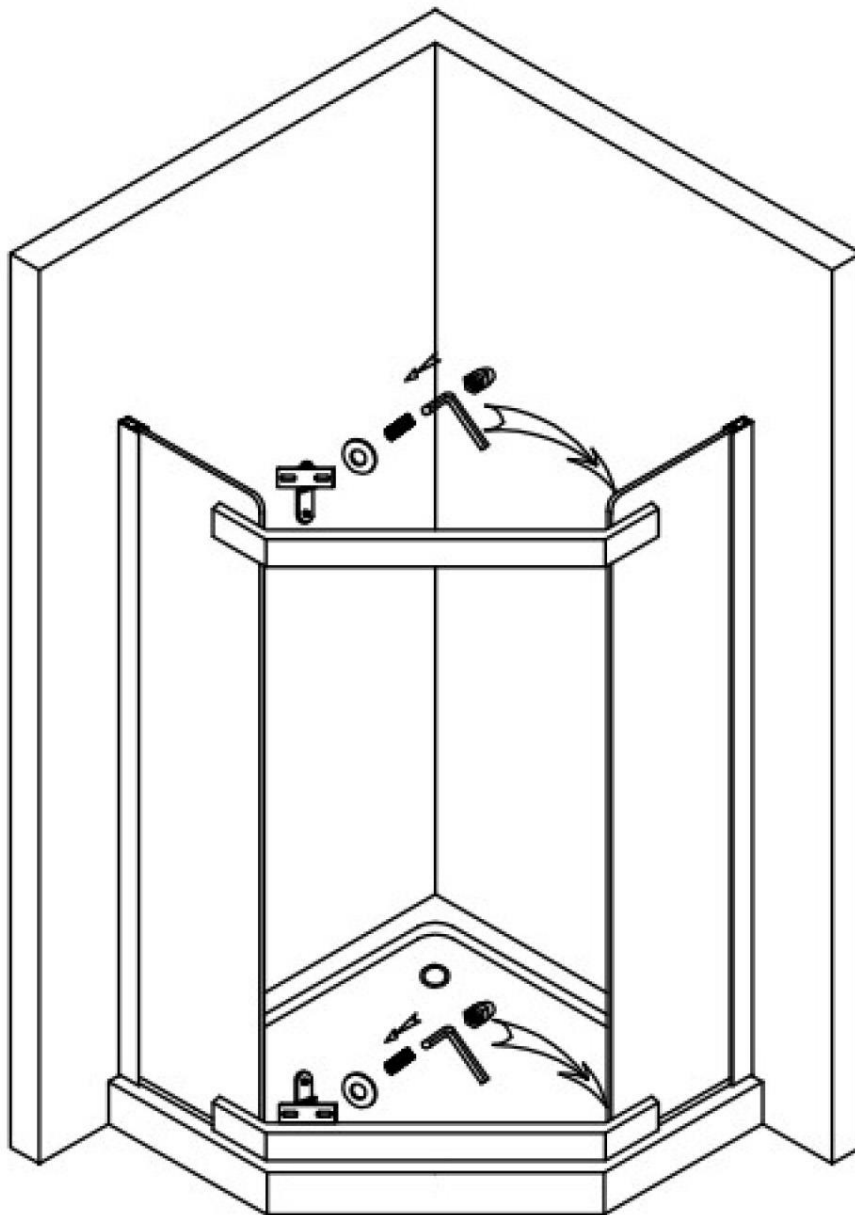
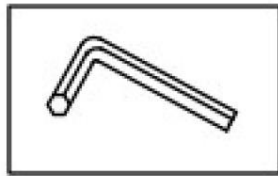
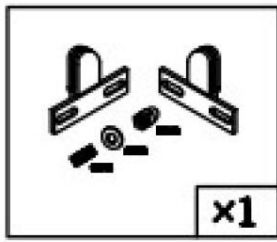

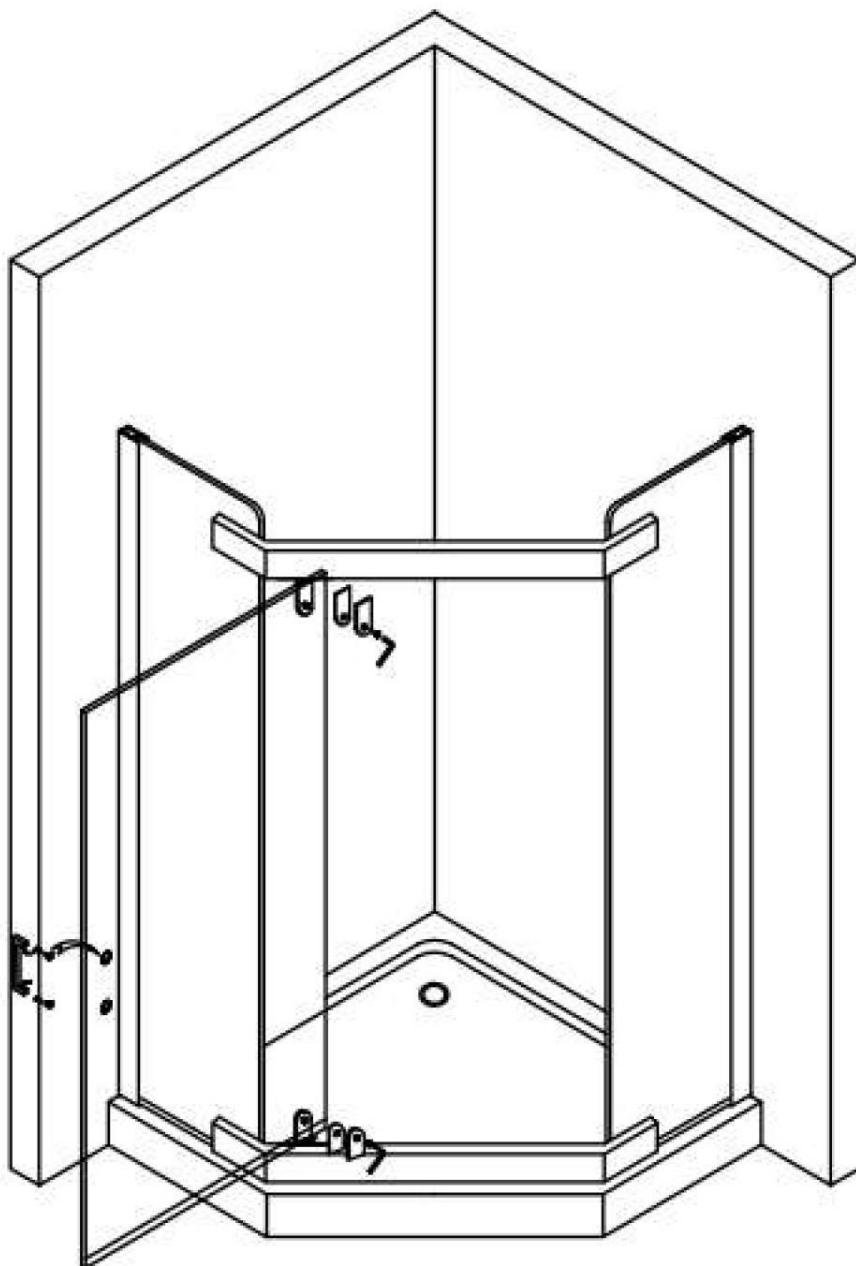
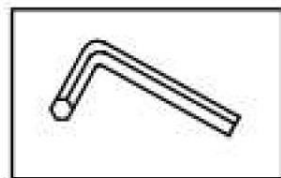
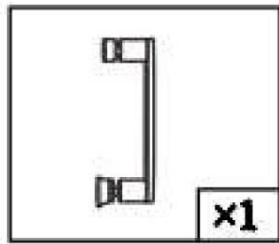
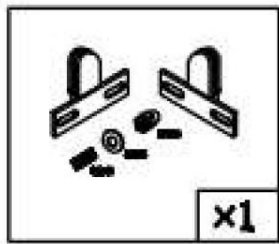
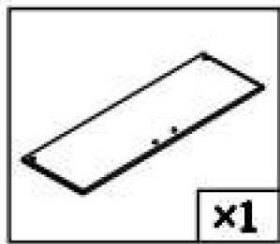

5

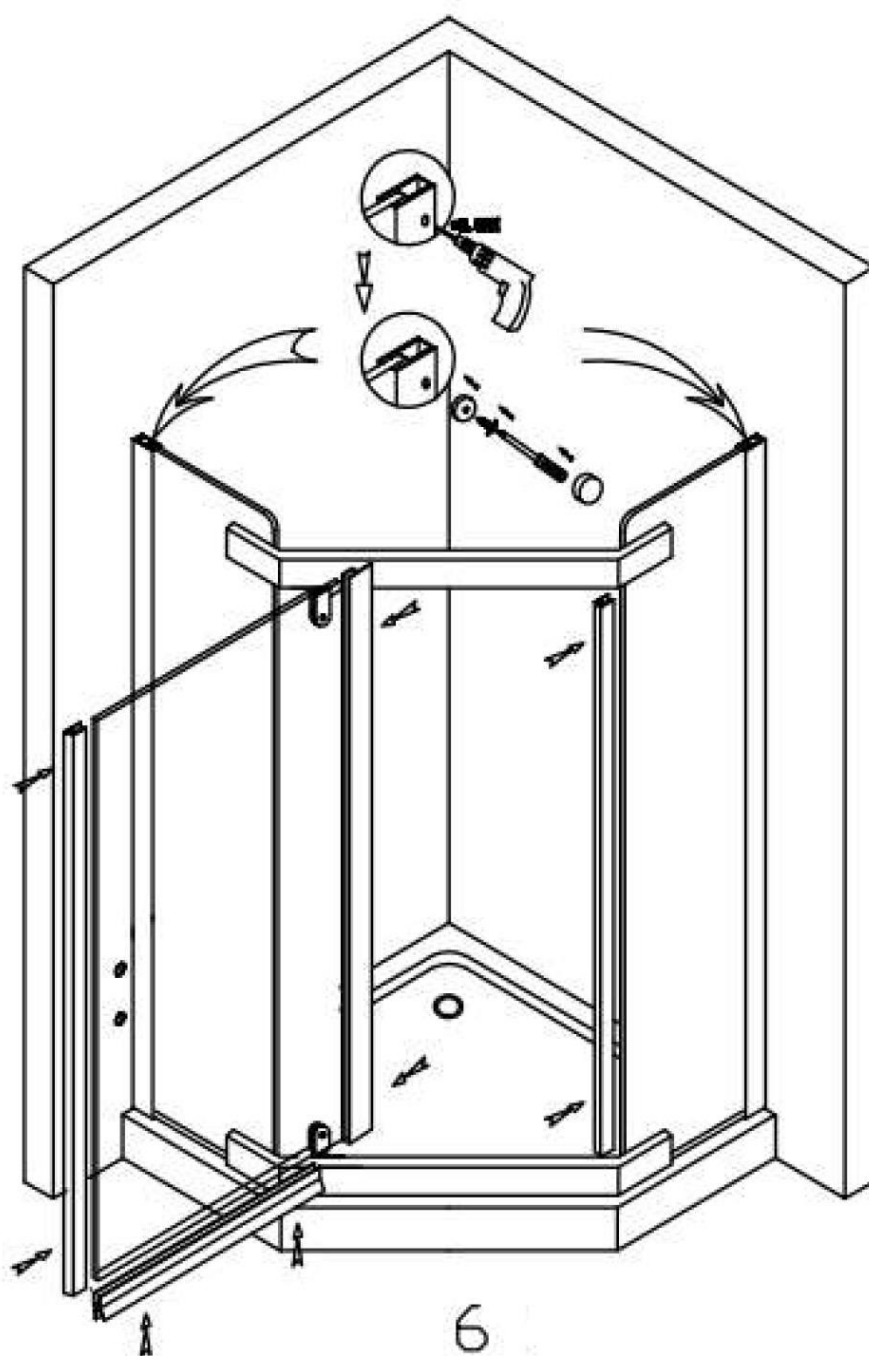
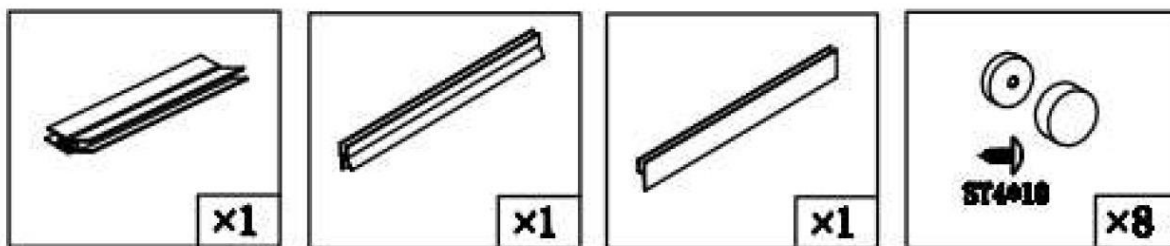

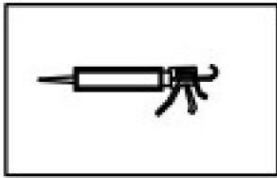

Po silikonování 24 nechejte řádně vytuhnout silikon!!!

